

STAGO KB284 ZINC+

PRODUCT BROCHURE 2022

Steel cable tray system

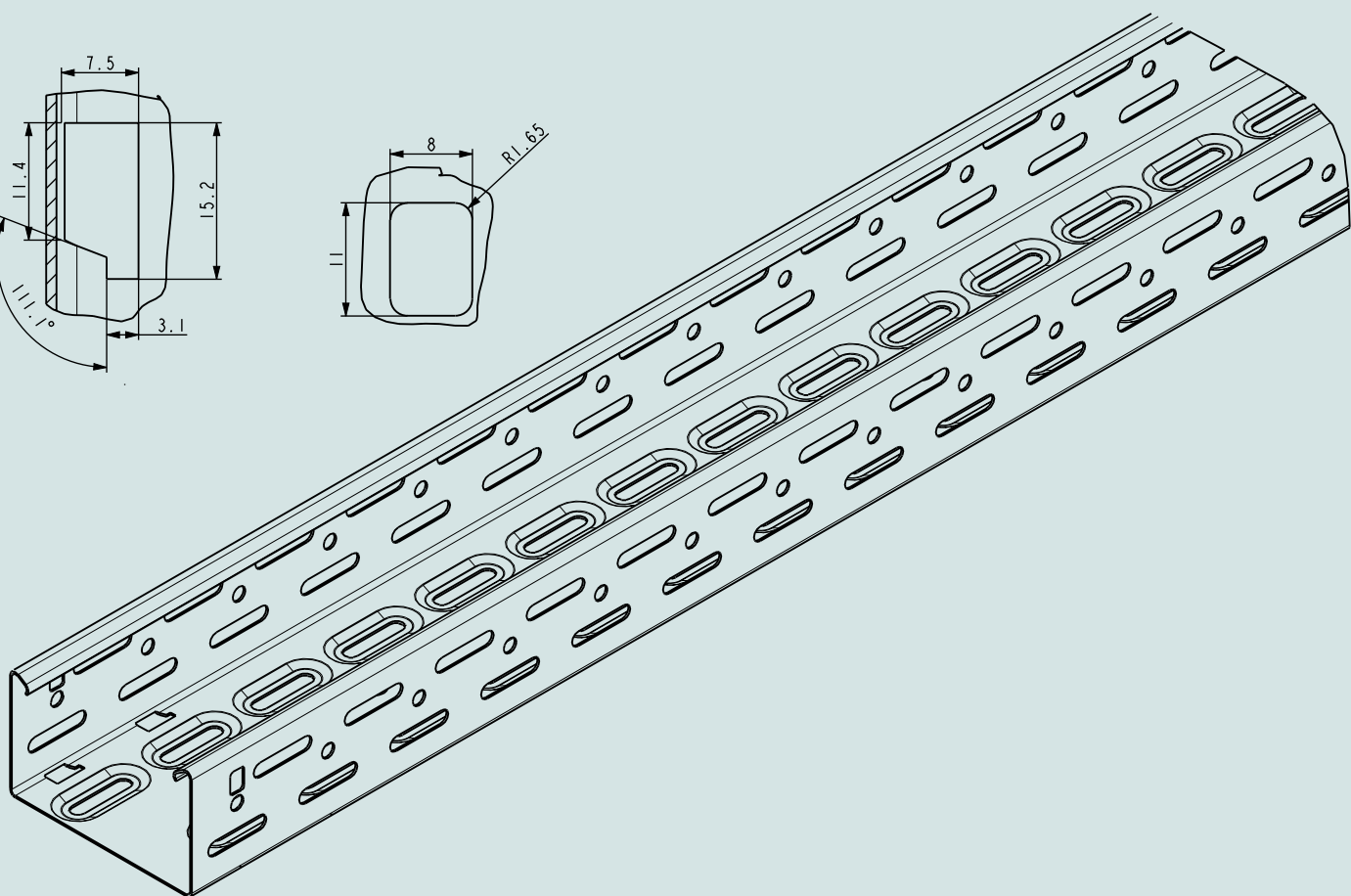
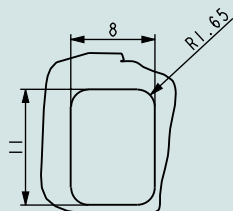
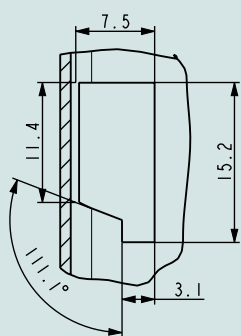

stago[®]
powered by wibe group



STAGO CABLE TRAYS

Durable cable trays for all types of installations

- Extensive range in different system heights, widths, lengths, perforation patterns, material thicknesses and surface treatments.
- Extensive range of form pieces and accessories to facilitate any track direction.
- Smart fast-fix accessories ensure efficient installation.
- Less deflections and high resistance to load: relatively high safe working load capacity.
- Zinc+ corrosion-resistant surface as an alternative to post hot dip galvanization in some of environmental conditions.
- Smooth, matt grey even thickness surface coating without burrs or flakes.
- Self-healing surface so damages and scratches do not impact on corrosion resistance.

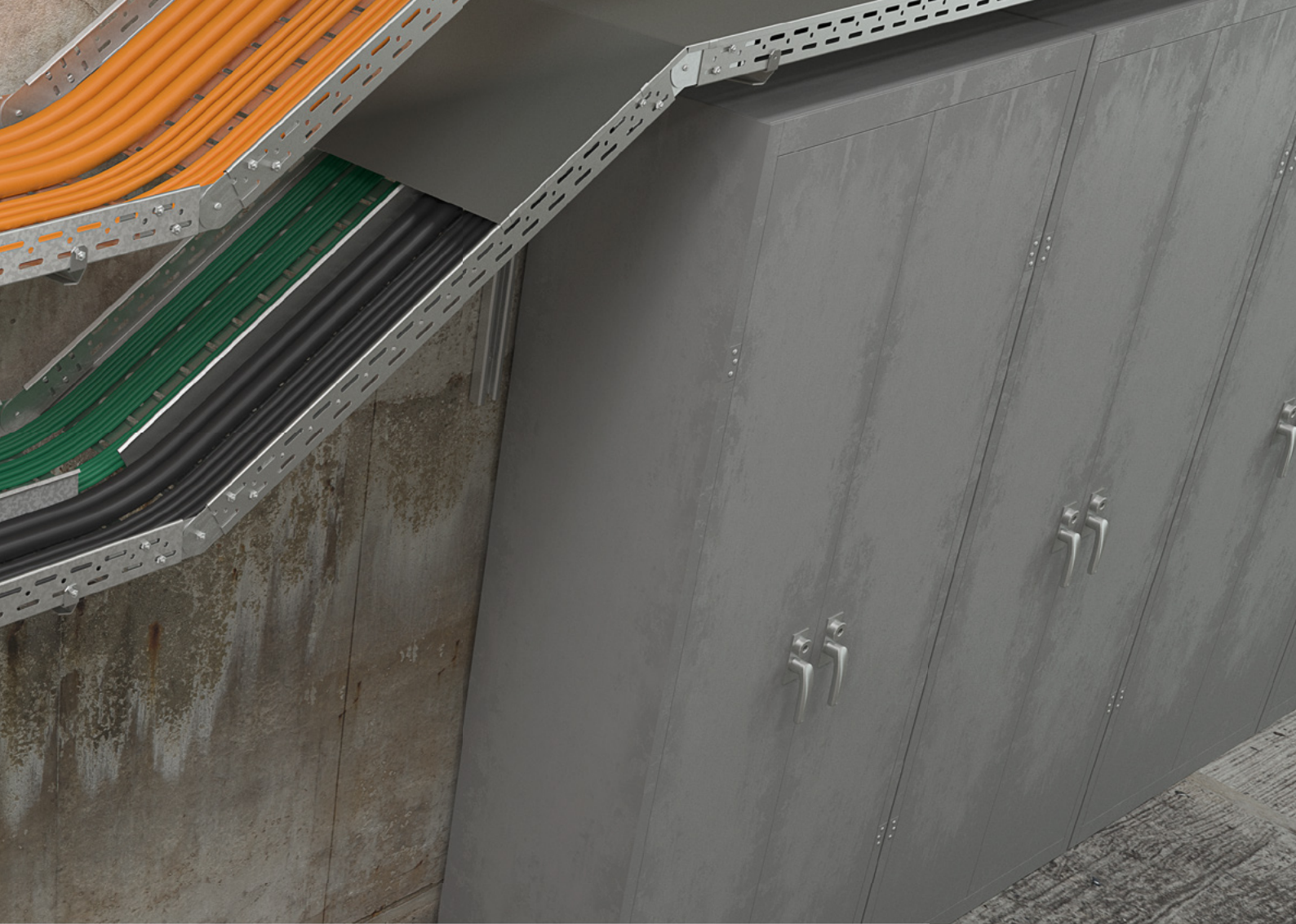

The Stago cable tray system consists of cable trays, covers, separation walls, form pieces, mounting accessories, wall and ceiling supports, and much more to provide standard and customized solutions.

Benefits

Stago cable trays in tunnel applications offer a high grade of cable protection and shield the cables from external influences like debris, dust, moisture, animals, etc. The enclosed compartment also helps prevent unauthorized access to the cables positioned at escape routes, service areas, etc. The sheet metal design provides an excellent level of EMC screen effectiveness during data signaling and when control cables need to be separated and interference avoided.

Thanks to the wide range of screw less accessories, Stago cable trays are quick and easy to install. The single pendant support with robust consoles leaves one side open, allowing fast and easy cable installation.

Specifications

Besides the mere metals, Stago offers the possibility to powder coat cable trays into any requested RAL color to facilitate clear and easy identification of different parts of the installation.

Pre-galvanized sheet steel, powder coated and pre-galvanized sheet steel, hot-dip galvanized sheet steel, zinc + sheet steel, and stainless-steel sheet steel. Available heights: 35mm, 60mm, 85mm, and 110mm. Available lengths: standard 3m lengths. Plus, various possibilities for customized lengths up to 6,3m.

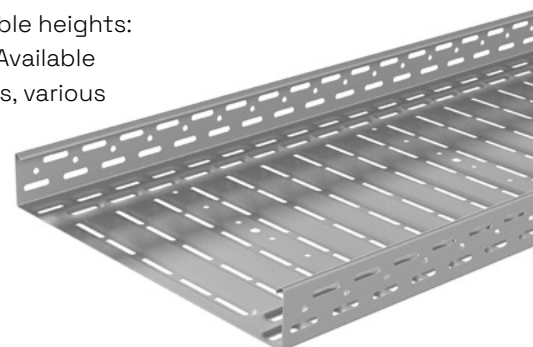



Content

Features and application	6
KB284 Zinc+	8
SWL Perforated & Reinforced tray	8
Length material	9
Form pieces	10
Support system	13
Mounting accessories.....	15
Index	20

Stago cable trays

Durable cable trays for all types of installations

The Stago Cable Tray System consists of cable trays, covers, separation walls, form pieces, mounting accessories, wall and ceiling supports, and much more to provide standard and customized solutions.

Features

With the expertise in roll forming and cable support manufacturing, Wibe Group offers a large assortment of universal accessories, screwless fixation solutions, modular accessories and easy to use form pieces for a speedy and efficient installation. Every installation is unique and requirements may vary. We provide comprehensive solutions and product customization is key to providing a tailored and optimized system for all of our customers' needs.

Specifications

- > Materials: Zinc+ sheet steel
- > Available height: 60 mm
- > Standard cable tray lengths: 3 m
- > Standard cover lengths: 2 m
- > KB284 cable trays with standard perforation pattern and base reinforcement for optimal performance. Available in pre-galvanized sheet steel and Zinc+ sheet steel material

Benefits

Simple and fast

Thanks to the wide range of screwless accessories Stago cable trays are quick and easy to install.

With efficiency in mind

Smart and universal accessories with flat form pieces to simplify purchasing, shipping, storage and assembly of procedures for our customers.

Ideal lengths

Certain applications demand cable trays longer or shorter than the market standard. With our customization workshop, customers can order the length they require and save the time that would have been needed to cut the cable trays on site.

More than grey and white

Besides the mere metals, Stago offers RAL 1013, RAL 9016, RAL 9010 and RAL 1023 colors as standard and has the possibility to powder coat cable trays into any requested color. Apply your own corporate colors on our system to make it fit in to any environment.

Optimized support system

The single pendant support with robust consoles leaves one side open, allowing fast and easy cable management. Suits all types of cable support.

Applications

Stago cable trays are designed for a wide range of environments in various industries, such as:

Corrosion classes as stipulated by SS-EN ISO 12944-2

C2 (Zinc+ According to EN 10346)

Outdoors: Atmospheres with low levels of airborne pollution.

Rural areas.

Indoors: Non-heated areas with fluctuating levels of temperature and humidity. Few instances of condensation and low levels of airborne pollution, e.g. sports hall warehouses.

C3 (Zinc+ According to EN 10346)

Outdoors: Atmospheres containing some salt or average levels of airborne pollution. Urban and light industrial areas. Areas affected by coastal conditions.

Indoors: Areas with average levels of humidity and some airborne pollution resulting from production processes, e.g. breweries, dairies, laundries.

C4 (Zinc+ According to EN 10346)

Outdoors: Atmospheres with average salt content or discernible levels of airborne pollution. Industrial and coastal areas.

Indoors: Areas of high humidity and considerable airborne pollution as the result of production processes, e.g. chemical plants, swimming pools and dockyards.

KB284 cable trays

Safety working load diagrams

The Stago trays are tested according to IEC 61537, by using the Safe Working Load (SWL) test type I (no limitations on the joints position along the supports distance) Uniform Distributed Load is applied along the width and length and SWL is determined after applying a safety factor of 1,7 times without collapse.

Joints used:

- Side couplers (fast fix coupler/bolted coupler)
- No bottom joints
- thickness 1 mm

CB certificate Nr. CE030CBES2428-AENOR

NEW - VDE certificate no 40054376



KB284, perforated trays

Height	Width	Thickness	Safety working load (1 m span)	Safety working load (1,5 m span) <i>CB certified</i>	Safety working load (2 m span)	Safety working load (3 m span)	Side Joint
mm	mm	mm	Kg/m	Kg/m	Kg/m	Kg/m	
60	100	1	169	104	72	30	CSU76030000 (Up to 400)
	150	1	181	104	72	30	
	200	1	193	104	72	30	
	250	1	-	-	-	-	
	300	1	170	96,5	72	30	CSU76030100 (for 500 & 600)
	400	1	158	89	68	28	
	500	1	123	81	64	25	
600	1	112	73	59	22		

KB284 Cable trays

Zinc+ Length material

Length material

Type	Dimensions A/B (mm) 	Length C (mm)	Weight kg/pcs	Ref. No.
Cable tray perforated L = 3000 mm				
Perforated steel cable tray for routing cables throughout the system. Designed with rounded safety edges to protect cables and bottom reinforcement for enhanced performance. 1 mm thickness. Connect individual lengths by using screless Unilock joint or by screw type coupler with M6 bolts & nuts. Finish: Zinc+.				
Cable tray perforated 60x100	60x100	3000		CSU46011004
Cable tray perforated 60x150	60x150	3000		CSU46011504
Cable tray perforated 60x200	60x200	3000		CSU46012004
Cable tray perforated 60x300	60x300	3000		CSU46013004
Cable tray perforated 60x400	60x400	3000		CSU46014004
Cable tray perforated 60x500	60x500	3000		CSU46015004
Cable tray perforated 60x600	60x600	3000		CSU46016004



Cover L = 2000 mm				
Optional cover can be mounted for enhanced cable protection against dust, fluids, UV etc. Delivered in 2 m length. Snap-on fixation to cable trays by using universal cover clamp (CSU08855000). Finish: Zinc+.				
Cover 100	100	2000		CSU88161104
Cover 150	150	2000		CSU88161504
Cover 200	200	2000		CSU88163004
Cover 300	300	2000		CSU88164304
Cover 400	400	2000		CSU88166004
Cover 500	500	2000		CSU88167004
Cover 600	600	2000		CSU88168004



Separation wall L = 3000 mm				
Use separation wall to create divided compartments in the cable tray length material. Fix to cable tray by using screwless grendel clamp (height 60 only) or by using M6x10 bolts & nuts. Finish: Zinc+.				
Separation wall 60	60	3000		CSU86020000



KB284 Cable trays

Zinc+Form Pieces

Form Pieces

Type	Dimensions A/B (mm)	Weight kg/pcs	Ref. No.
------	------------------------	------------------	----------

90° Bend

Can be used to construct horizontal 90° direction changes at any desired position in the cable tray. Use screwless fixing clip for flat form pieces (CSU08856050) or M6x10 bolts & nuts to fix to the cable tray. Finish: Zinc+.



90° Bend 60x100	60x100		CSU86061004
90° Bend 60x150	60x150		CSU86061504
90° Bend 60x200	60x200		CSU86062004
90° Bend 60x300	60x300		CSU86063004
90° Bend 60x400	60x400		CSU86064004
90° Bend 60x500	60x500		CSU86065004
90° Bend 60x600	60x600		CSU86066004

90° Bend cover

Optional 90° bend cover for enhanced cable protection. Snap-on fixation to the form piece by using universal cover clips (CSU08855000). Finish: Zinc+.

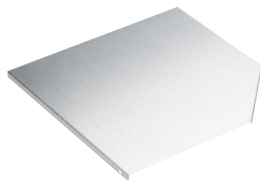

90° Bend cover 100	100		CSU80061004
90° Bend cover 150	150		CSU80061504
90° Bend cover 200	200		CSU80062004
90° Bend cover 300	300		CSU80063004
90° Bend cover 400	400		CSU80064004
90° Bend cover 500	500		CSU80065004
90° Bend cover 600	600		CSU80066004

Adjustable corner piece

Can be used to construct variable horizontal bends in the cable tray system. Use screwless fixing clip for flat form pieces (CSU08856050) or M6x10 bolts & nuts to fix to the cable tray. Finish: sheet steel, Zinc+.



Adjustable corner piece 60x100	60x100		CSU86521004
Adjustable corner piece 60x150	60x150		CSU86521504
Adjustable corner piece 60x200	60x200		CSU86522004
Adjustable corner piece 60x300	60x300		CSU86523004
Adjustable corner piece 60x400	60x400		CSU86524004
Adjustable corner piece 60x500	60x500		CSU86525004
Adjustable corner piece 60x600	60x600		CSU86526004

Branching piece

Can be used to construct perpendicular branches at any desired position in the cable tray. Use screwless fixing clip for flat form pieces (CSU08856050) or M6x10 bolts & nuts to fix to the cable tray. Finish: Zinc+.



Branching piece 60x100	60x100		CSU86071004
Branching piece 60x150	60x150		CSU86071504
Branching piece 60x200	60x200		CSU86072004
Branching piece 60x300	60x300		CSU86073004
Branching piece 60x400	60x400		CSU86074044
Branching piece 60x500	60x500		CSU86075004
Branching piece 60x600	60x600		CSU86076004

Branching piece cover

Optional branching piece cover for enhanced cable protection. Snap-on fixation to the form piece by using universal cover clips (CSU08855000). Finish: Zinc+.









Branching piece cover 100	100		CSU80071004
Branching piece cover 150	150		CSU80071504
Branching piece cover 200	200		CSU80072004
Branching piece cover 300	300		CSU80073004
Branching piece cover 400	400		CSU80074004
Branching piece cover 500	500		CSU80075004
Branching piece cover 600	600		CSU80076004

KB284 Cable trays

Zinc+ Form Pieces

Form pieces

	Type	Dimensions* A/B (mm) 	Weight kg/pcs	Ref. No.
	T-piece			
	Can be used to construct horizontal T-intersections at any desired position in the cable tray. Use screwless fixing clip for flat form pieces (CSU08856050) or M6x10 bolts & nuts to fix to the cable tray. Finish: Zinc+.			
	T-piece 60x100	60x100		CSU86151004
	T-piece 60x150	60x150		CSU86151504
	T-piece 60x200	60x200		CSU86152004
	T-piece 60x300	60x300		CSU86153004
	T-piece 60x400	60x400		CSU86154004
	T-piece 60x500	60x500		CSU86155004
	T-piece 60x600	60x600		CSU86156004
	T-piece cover			
	Optional T-piece cover for enhanced cable protection. Snap-on fixation to the form piece by using universal cover clips (CSU08855000). Finish: Zinc+.			
	T-piece cover 100	100		CSU80151004
	T-piece cover 150	150		CSU80151504
	T-piece cover 200	200		CSU80152004
	T-piece cover 300	300		CSU80153004
	T-piece cover 400	400		CSU80154004
	T-piece cover 500	500		CSU80155004
	T-piece cover 600	600		CSU80156004
	X-piece			
	Can be used to construct horizontal cross intersections at any desired position in the cable tray. Use screwless fixing clip for flat form pieces (CSU08856050) or M6x10 bolts & nuts to fix to the cable tray. Finish: Zinc+.			
	X-piece 60x100	60x100		CSU86161004
	X-piece 60x150	60x150		CSU86161504
	X-piece 60x200	60x200		CSU86162004
	X-piece 60x300	60x300		CSU86163004
	X-piece 60x400	60x400		CSU86164004
	X-piece 60x500	60x500		CSU86165004
	X-piece 60x600	60x600		CSU86166004
	X-piece cover			
	Optional X-piece cover for enhanced cable protection. Snap-on fixation to the form piece by using universal cover clips (CSU08855000). Finish: Zinc+.			
	X-piece cover 100	100		CSU80161004
	X-piece cover 150	150		CSU80161504
	X-piece cover 200	200		CSU80162004
	X-piece cover 300	300		CSU80163004
	X-piece cover 400	400		CSU80164004
	X-piece cover 500	500		CSU80165004
	X-piece cover 600	600		CSU80166004
	Internal riser			
	Can be used to construct vertical 90° upwards direction changes at any desired position in the cable tray. Use screwless fixing clip for flat form pieces (CSU08856050) or M6x10 bolts & nuts to fix to the cable tray. Finish: Zinc+.			
	Internal riser 60x100	60x100		CSU86231004
	Internal riser 60x150	60x150		CSU86231504
	Internal riser 60x200	60x200		CSU86232004
	Internal riser 60x300	60x300		CSU86233004
	Internal riser 60x400	60x400		CSU86234004
	Internal riser 60x500	60x500		CSU86235004
	Internal riser 60x600	60x600		CSU86236004

KB284 Cable trays

Zinc+ Form pieces

Form pieces

Type	Dimensions A/B (mm) 	Weight kg/pcs	Ref. No.
------	---	---------------	----------

Internal riser cover

Optional Internal riser cover for enhanced cable protection. Snap-on fixation to the form piece by using universal cover clips (CSU08855000). Finish: Zinc+.



Internal riser cover 100	100		CSU80231004
Internal riser cover 150	150		CSU80231504
Internal riser cover 200	200		CSU80232004
Internal riser cover 300	300		CSU80233004
Internal riser cover 400	400		CSU80234004
Internal riser cover 500	500		CSU80235004
Internal riser cover 600	600		CSU80236004

External riser

Can be used to construct vertical 90° downwards direction changes at any desired position in the cable tray. Use screwless fixing clip for flat form pieces (CSU08856050) or M6x10 bolts & nuts to fix to the cable tray. Finish: Zinc+.



External riser 60x100	60x100		CSU86221004
External riser 60x150	60x150		CSU86221504
External riser 60x200	60x200		CSU86222004
External riser 60x300	60x300		CSU86223004
External riser 60x400	60x400		CSU86224004
External riser 60x500	60x500		CSU86225004
External riser 60x600	60x600		CSU86226004

External riser cover

Optional External riser cover for enhanced cable protection. Snap-on fixation to the form piece by using universal cover clips (CSU08855000). Finish: Zinc+.



External riser cover 100	100		CSU80221004
External riser cover 150	150		CSU80221504
External riser cover 200	200		CSU80222004
External riser cover 300	300		CSU80223004
External riser cover 400	400		CSU80224004
External riser cover 500	500		CSU80225004
External riser cover 600	600		CSU80226004

Universal angle connector

Can be used to cover gaps between cable trays placed perpendicularly in a flexible and aesthetic way. Use M6x10 bolts & nuts to fix to the cable tray. Finish: Zinc+.



CSU8610002-2.jpg

Universal angle connector 60	60		CSU86110004
------------------------------	----	--	--------------------

Universal angle connector cover

Optional universal angle connector cover for enhanced cable protection. Snap-on fixation to the form piece by using universal cover clips (CSU08855000). Finish: Zinc+.



CSU088980000.jpg

Universal angle connector cover	-		CSU88980000
---------------------------------	---	--	--------------------

End plate / Reducer piece

Can be used as an end cover or as a reducer, also applicable to construct horizontal bends. Fix to the cable tray with M6x10 bolts & nuts. Finish: Zinc+.



End plate / Reducer piece 60x100	60x100		CSU86041000
End plate / Reducer piece 60x150	60x150		CSU86041500
End plate / Reducer piece 60x200	60x200		CSU86042000
End plate / Reducer piece 60x300	60x300		CSU86043000
End plate / Reducer piece 60x400	60x400		CSU86044000
End plate / Reducer piece 60x500	60x500		CSU86045000
End plate / Reducer piece 60x600	60x600		CSU86046000

Universal reducing piece

Universal reducer to be used for transition joining from wide to a narrower cable tray. The shorter length reducer is suitable up to size 300 and use longer length when bigger width is needed. Finish: Zinc+.



CSU088940000.jpg

Universal reducing piece 60 L = 607	60		CSU88940000
Universal reducing piece 60 L = 957	60		CSU88960000

KB284 Cable trays

Zinc+ Support system

Support system

Type	Dimensions A/B (mm)	Length C (mm)	Weight kg/pcs	Ref. No.
------	------------------------	------------------	------------------	----------

Suspension beam

Suspension beam for double-threaded rod suspended installation. Use bolts M6x10, nuts to fix cable tray to the beam.
Finish: steel, Hot dip galvanized



P140896.jpg

Suspension beam 100	100			791063
Suspension beam 200	200			791064
Suspension beam 300	300			791065
Suspension beam 400	400			791068
Suspension beam 500	500			791067
Suspension beam 600	600			791068

C-Bracket

C-bracket for single central suspended threaded rod installation. Use bolts M6x10, nuts to fix cable tray to the bracket.
Finish: steel, Hot-dip galvanized.



C-Bracket Medium 100	100			CSU08173100
C-Bracket Medium 150	150			CSU08171500
C-Bracket Medium 200	200			CSU08173200
C-Bracket Medium 300	300			CSU08173300
C-Bracket Heavy 400	400			CSU14174000
C-Bracket Heavy 500	500			CSU14175000
C-Bracket Heavy 600	600			CSU14176000

Cantilever arms

Cantilever arm to be used for mountings on walls, vertical pieces or pendant/fixing rails.
Finish: steel, Hot-dip galvanized.



Cantilever arm 50i 100	100			CSU795316
Cantilever arm 50i 200	200			CSU795317
Cantilever arm 50i 300	300			CSU795318
Cantilever arm 50i 400	400			CSU795319
Cantilever arm 50i 500	500			CSU795320
Cantilever arm 50i 600	600			CSU795321

Cantilever arm 50

Cantilever arm for mounting on walls, pendant/fixing rails or vertical pieces.
Finish: Steel, hot-dip galvanized.



P140078

50-100	85/150/40	24	7321677234325	723432
50-150	85/200/40	28	7321677234332	723433
50-200	85/250/40	34	7321677234349	723434
50-250	105/300/40	52	7321677234356	723435
50-300	105/350/40	60	7321677234363	723436
50-400	120/450/50	228	7321677234370	723437
50-500	140/550/50	172	7321677234387	723438
50-600	150/650/50	215	7321677234394	723439

Threaded rod

Threaded rod for suspended installations.
Finish: steel, Zinc flake.



Threaded rod M10	M10	2000		CSU08051020
------------------	-----	------	--	--------------------

Nut and washer

For fastening of threaded rod to bracket / C bracket.
Finish: steel, Zinc flake.



Nut M10	M10			CSU08890120
Washer M10	M10			CSU08900020

KB284 Cable trays

Zinc+ Support system

Support system



csu08020200.jpg

Type	Dimensions A/B (mm)	Length C (mm)	Weight kg/pcs	Ref. No.
Ceiling attachment-open				
Use ceiling bracket for plain ceiling. Fix rod with two pieces of M10 nuts. Finish: steel, Hot-dip galvanized.				
Ceiling attachment-open				CSU08020200



PI329358.eps

Vertical piece 2F				
Length of the pendant can be extended by using pendant fixing rail 24/48 and rail connector 2FJ. Finish: steel, Hot-dip galvanized.				
Vertical piece 2F 280	280			717196
Vertical piece 2F 370	370			717197
Vertical piece 2F 505	505			717198
Vertical piece 2F 640	640			CSU794202
Vertical piece 2F 730	730			717199
Vertical piece 2F 865	865			CSU794203
Vertical piece 2F 1000	1000			717200
Vertical piece 2F 1500	1500			787276



PI32942.eps

Vertical piece 20 Double				
Vertical piece, two-sided, to be used for vertical installation together with Cantilever arm 50, from a ceiling or on a floor. Can also be installed as a cantilever arm on a wall. Finish: steel, Hot-dip galvanized.				
Vertical piece 20 Double 280	280			CSU794204
Vertical piece 20 Double 370	370			CSU794205
Vertical piece 20 Double 505	505			715723
Vertical piece 20 Double 640	640			CSU794206
Vertical piece 20 Double 730	730			715724
Vertical piece 20 Double 865	865			CSU794207
Vertical piece 20 Double 1000	1000			715725
Vertical piece 20 Double 1495	1495			715726



PI40098.eps







End Plug 28E				
High visibility end plug for enhanced safety and easy identification. Finish: PP/TPE, orange.				
End Plug 28D				709020
End Plug 28E				709021



T-Bolt				
Bolts, nuts and washers are delivered in a bag of 100 pieces. Finish: steel, Hot-dip galvanized				
T-bolt 26U M8	M8x30	30		CSU795595
T-bolt 26U M10	M10x30	50		CSU795589
T-bolt 26U M10	M10x40	60		CSU795590









KB284 Cable trays

Zinc+ Mounting accessories

Mounting accessories			
Type	Dimensions A/B (mm)	Weight kg/pcs	Ref. No.
Side joint			
Internal coupler to joint two lengths of cable trays. Fixation with bolts M6x10 & nuts. Use 2 couplers per cable tray. Finish: Zinc+.			
	Side joint 60	60	CSU86030000
Screwless side joint			
Screwless snap-in internal coupler for system height 60 to be used to joint two lengths of cable trays. Optional fixation with bolts M6x10 & nuts. Use 2 couplers per cable tray. Finish: Zinc+			
	Unilock Screwless side joint 60	60	CSU88010109
Bottom joint			
Optional sleeve-on bottom coupler for enhanced system alignment and performance. Finish: Zinc+.			
	Bottom joint 300	300	CSU80703000
	Bottom joint 400	400	CSU80704000
	Bottom joint 500	500	CSU80705000
	Bottom joint 600	600	CSU80706000
Hinge coupler			
Can be used to construct any type of level change at any point of the cable tray installation. Use 2 couplers per cable tray. To be used in combination with bolts M6x10 & nuts. Finish: Zinc+.			
	Hinge coupler 60	60	CSU86120009
Universal cover clamp			
Universal cover clamp for snap-on fixation of the covers. Delivered in a bag of 100 pieces. Use 4 pieces on each meter. Finish: Stainless steel.			
	Universal cover clamp		CSU08855000
Captive cover clamp			
C-shape cover clamp designed for outdoor use and vertical installations. Finish: Stainless steel.			
	Captive cover clamp 60	60	CSU76240000
Fixing clip for flat form pieces			
Use screwless fixing clip to fix form pieces on the cable trays. Available for system height 60 only. Finish: Stainless steel.			
	Fixing clip for flat form pieces 60	60	CSU08856050

KB284 Cable trays

Zinc+ Mounting accessories

Mounting accessories				
Type	Dimensions A/B (mm)		Weight kg/pcs	Ref. No.
Bolt & nut				
Bolts, nuts and washers are delivered in a bag of 100 pieces. Finish: Zinc flake				
 <small>csu0846000-1.jpg</small>	Bolt M6x10	M6x10		CSU08462020
 <small>csu08461000-2.jpg</small>	Flange nut M6	M6		CSU08461020
Earthing clamp				
Earthing clamp for earthing of the installation to comply with safety requirements. Fix to the lateral of the cable tray. Suits cables from 16 to 70 mm ² . Finish: brass, electrolytical nickel coating.				
 <small>P112470.eps</small>	Earthing clamp			4571310
Protection strip				
Protection strip. To be used to protect cutted edges in the cable tray. Delivered as roll of 5 m. Finish: PVC, black.				
 <small>P146884.eps</small>	Protection strip 5 m	5 m		CSU08040000
Cutting sear				
Use manual or electric metal shears to ensure a fast, safe and clean cut of cable tray length material. Finish: steel.				
 <small>csu08770100.jpg</small>	Cutting shear manual			CSU08770100
 <small>P147022.eps</small>	Cutting shear electric			CSU08770200
 <small>P147023.eps</small>	Electric shear replacement knife			CSU08780200
Strip fixing W44				
Modular cable retainer. Suited with double sided self-adhesive tape to be fixed inside the cable tray. Delivered in 10 cm pieces in a bag of 50. Finish: PPE.				
 <small>P148804.eps</small>	Strip fixing W44			718469

15 years guarantee on corrosion protection for C4 class on corrosion environments.



Type Approval and decision on production control

SC0924-17

Cable tray KB184 and KB284 system, Corrosion protection

Holder/Issued to

Schneider Electric Sverige AB

Cable Support Line of Business, Wibevägen 1, 792 36 Mora, Sweden

Organisation number/VAT number: SE556259353201

Phone: +46 10 478 35 51

E-mail: jimmy.qvicker@schneider-electric.com, Web: www.schneider-electric.com

Product description

Cable tray system KB184 and KB284 with Zinc+ as corrosion protection. Zinc+ is a zinc-magnesium-aluminium special coating. Components included in the system according to Appendix A.

The Cable trays can be provided with a layer of powder coating on the corrosion protection layer.

Intended use

Intended as Cable tray system for support and accommodation of cables and possibly other electrical equipment in indoor- and outdoor applications with Zinc+ as corrosion protection.

The corrosion protection is suitable for corrosivity class C4, according to in SS-EN ISO 12944-2 described class, based on a deemed expected lifetime of 15 years.

Trade name

Cable tray KB184 and KB284 system.

Approval

The products satisfies the requirements set forth in chapter 8, 4 § 4 PBL, in respect to and under conditions stated in this certificate, and are therefore approved in accordance with the provisions of the following section of Boverket Building Regulations (BBR) issued by the National Board of Housing, Building and Planning:

Safety at use, Protection against electric shocks 8:8

Associated documents

-

Control

The factory production control (FPC) is monitored by an independent inspection body.

Control agreement: 210-04-0208, Inspection body: RISE Research Institutes of Sweden AB

When the building proprietor performs inspection at the building site markings shall be checked to ensure that the correct products have been supplied and that they are used in accordance with the conditions in this approval and associated documents. Further the product shall be accompanied by a manufacturer's assurance, certifying that the product has been manufactured in accordance with the documents on which this approval is based.

Type approval SC0924-17| 2017-09-21

RISE Research Institutes of Sweden AB | Certification
Box 857, SE-501 15 Borås, Sweden
Phone: +46 10-516 50 00
certifying@ri.se www.ri.se



This document may not be reproduced other than in full, except with the prior written approval by RISE Certification.

Page 1 (2)



Corrosion control
- the smart way



Unilock joint facilitates a fast installation without compromising the load carrying capabilities.



KB284 Zinc+ gives excellent corrosion resistance together with a perfect finish. And no deformation resulting from high temperature exposure during the hot-dip galvanizing process. Smooth and aesthetic surface finish. No burnings, no zinc webs and no zinc drips. Self-repairing cathodic protection of cut edges and surface damages. Excellent ductility.

All KB284 cable trays are sturdy, thanks to their construction. But a robust design isn't enough when trays are installed in demanding environments, such as the chemical industry, or in acid or alkaline atmospheres. To endure these conditions trays need to be supplied with a higher resistance to corrosion.

Stainless steel is a very reliable, but also a rather expensive choice. Hot dip galvanized (HDG) trays are the price and trustworthy alternative, but they often have an uneven surface with zinc webs and zinc drips, caused by the hot-dip galvanizing process.

Sometimes, and for some installations you don't want

to risk any friction, strain or unnecessary scratches to the cables – or to the installer's hands. That's when you need our new range of KB284 Zinc+ cable trays.

Smooth as stainless steel, with a corrosion resistance comparable to HDG but more environmental friendly and self-healing properties.

KB284Z+ Calbe

To address all weak spots we are using a new innovative technique, where the material is evenly coated with a new substance, before the products are constructed.

The surface coating is basically consisting of zinc and aluminium. This results in an excellent galvanic protection and a smooth and aesthetic finish, without any irregularities.

KB284 Zinc+ is made with a metallic alloyed coating based in Zinc, in combination with Aluminium and Magnesium and

has a superior coating ductility comparable with HDG and can easily be bent into shape without ever getting cracks and losing their protective ability. If scratched the surface is close to self repairing. Salt spray tests prove that KB284 Zinc+ system providing an excellent corrosion protection (class 8 according to EN 61537 for the complete system).

Zinc+ is a fitting alternative to HDG materials with the added benefit of the self-healing property.

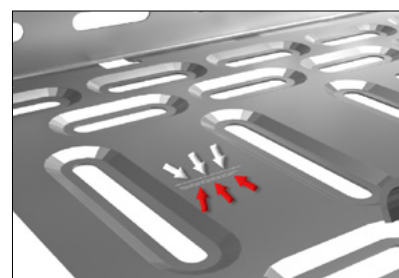
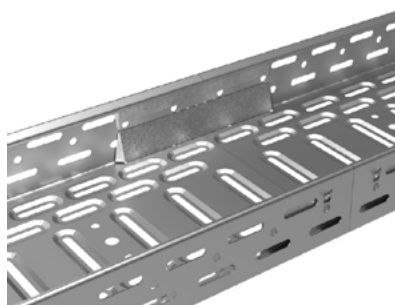

Index

Numbers

709020.....	14	CSU08960000.....	12	CSU36110002.....	12
709021.....	14	CSU08980000.....	12	CSU36151002.....	11
715723.....	14	CSU14174000.....	13	CSU36151502.....	11
715724.....	14	CSU14175000.....	13	CSU36152002.....	11
715725.....	14	CSU14176000.....	13	CSU36153002.....	11
715726.....	14	CSU26011002.....	9	CSU36154002.....	11
717196.....	14	CSU26011502.....	9	CSU36155002.....	11
717197.....	14	CSU26012002.....	9	CSU36156002.....	11
717198.....	14	CSU26013002.....	9	CSU36161002.....	11
717199.....	14	CSU26014002.....	9	CSU36161502.....	11
717200.....	14	CSU26015004.....	9	CSU36162002.....	11
718469.....	16	CSU26016004.....	9	CSU36163002.....	11
723432.....	13	CSU30061002.....	10	CSU36164002.....	11
723433.....	13	CSU30061502.....	10	CSU36165002.....	11
723434.....	13	CSU30062002.....	10	CSU36166002.....	11
723435.....	13	CSU30063002.....	10	CSU36221002.....	12
723436.....	13	CSU30064002.....	10	CSU36221502.....	12
723437.....	13	CSU30065002.....	10	CSU36222002.....	12
723438.....	13	CSU30066002.....	10	CSU36223002.....	12
723439.....	13	CSU30071002.....	10	CSU36224002.....	12
734983.....	14	CSU30071502.....	10	CSU36225002.....	12
787276.....	14	CSU30072002.....	10	CSU36226002.....	12
4571310.....	16	CSU30073002.....	10	CSU36231002.....	11
		CSU30074002.....	10	CSU36231502.....	11
		CSU30075002.....	10	CSU36232002.....	11

CSU

CSU794202.....	14	CSU30076002.....	10	CSU36233002.....	11
CSU794203.....	14	CSU30151002.....	11	CSU36234002.....	11
CSU794204.....	14	CSU30151502.....	11	CSU36235002.....	11
CSU794205.....	14	CSU30152002.....	11	CSU36236002.....	11
CSU794206.....	14	CSU30153002.....	11	CSU36521002.....	10
CSU794207.....	14	CSU30154002.....	11	CSU36521502.....	10
CSU795589.....	14	CSU30155002.....	11	CSU36522002.....	10
CSU795590.....	14	CSU30156002.....	11	CSU36523002.....	10
CSU08010000.....	15	CSU30161002.....	11	CSU36524002.....	10
CSU08010109.....	15	CSU30161502.....	11	CSU36525002.....	10
CSU08020200.....	14	CSU30162002.....	11	CSU36526002.....	10
CSU08040000.....	16	CSU30163002.....	11	CSU70703000.....	15
CSU08041000.....	13	CSU30164002.....	11	CSU70704000.....	15
CSU08043000.....	13	CSU30165002.....	11	CSU70705000.....	15
CSU08044500.....	13	CSU30166002.....	11	CSU70706000.....	15
CSU08046100.....	13	CSU30221002.....	12	CSU76001002.....	9
CSU08047100.....	13	CSU30221502.....	12	CSU76001502.....	9
CSU08048100.....	13	CSU30222002.....	12	CSU76002002.....	9
CSU08050000.....	13	CSU30223002.....	12	CSU76003002.....	9
CSU08161103.....	9	CSU30224002.....	12	CSU76004002.....	9
CSU08161503.....	9	CSU30225002.....	12	CSU76005004.....	9
CSU08163003.....	9	CSU30226002.....	12	CSU76006004.....	9
CSU08164303.....	9	CSU30231002.....	12	CSU76020000.....	9
CSU08166004.....	9	CSU30231502.....	12	CSU76041000.....	12
CSU08167004.....	9	CSU30232002.....	12	CSU76041500.....	12
CSU08168004.....	9	CSU30233002.....	12	CSU76042000.....	12
CSU08171500.....	13	CSU30234002.....	12	CSU76043000.....	12
CSU08173109.....	13	CSU30235002.....	12	CSU76044000.....	12
CSU08173200.....	13	CSU30236002.....	12	CSU76045000.....	12
CSU08173209.....	13	CSU36061002.....	10	CSU76046000.....	12
CSU08173300.....	13	CSU36061502.....	10	CSU76120009.....	15
CSU08173309.....	13	CSU36062002.....	10	CSU76240000.....	15
CSU08176209.....	13	CSU36063002.....	10		
CSU08461000.....	16	CSU36064002.....	10		
CSU08462000.....	16	CSU36065002.....	10		
CSU08770100.....	16	CSU36066002.....	10		
CSU08770200.....	16	CSU36071002.....	10		
CSU08780200.....	16	CSU36071502.....	10		
CSU08855000.....	15	CSU36072002.....	10		
CSU08856050.....	15	CSU36073002.....	10		
CSU08900020.....	13	CSU36074002.....	10		
CSU08920000.....	13	CSU36075002.....	10		
CSU08940000.....	12	CSU36076002.....	10		



Wibe Group & sustainability

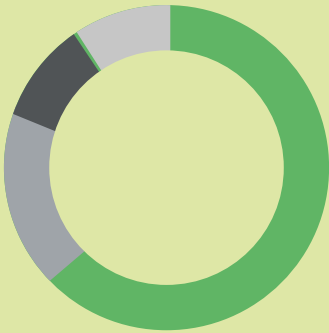

CO₂ and P&L impact through... Resource Performance

Green Premium brings improved resource efficiency throughout an asset's lifecycle. This includes efficient use of energy and natural resources, along with the minimization of CO₂ emissions.

Cost of ownership optimization through... Circular Performance

We're helping our customers optimize the total cost of ownership of their assets. To do this, we provide IoT-enabled solutions, as well as upgrade, repair, retrofit, and remanufacture services.

Peace of mind through... Well-being Performance

Green Premium products are RoHS and REACH compliant. We're going beyond regulatory compliance with step-by-step substitution of certain materials and substances from our products.

Improved sales through... Differentiation

Green Premium delivers strong value propositions through third-party labels and services. By collaborating with third-party organizations we can support our customers in meeting their sustainability goals such as green building certifications.

